

- **Style: Simple**
- **Size: Micro Case supports up to Micro ATX MB**
- **Material: Steel & Tempered Glass**

### Main Features

- **Connection :** Front I/O ports with USB 3.0 x 2 + USB 2.0 x 1
- **Ventilation:** Preinstalled 120mm ARGB PWM fan x 2
- **Support :** Supports AIO cooling solutions



## Specification

Model	Divider 170 TG ARGB	Divider 170 TG ARGB Snow
P/N	CA-1S4-00S1WN-00	CA-1S4-00S6WN-00
Case Type	Micro Case	
Chassis Dimension (H*W*D)	426 x 210 x 408.5 mm (16.8 x 8.3 x 16.1 inch)	
Net Weight	5.26 kg / 11.6 lbs.	
Side Panel	3mm Tempered Glass x 1	
Color	Black	White
Material	SPCC	
Cooling System	<b>Front(intake):</b> 120 x 120 x 25 mm ARGB PWM fan (1500rpm, 27.2 dBA) x 2	
Drive Bays	2 x 3.5", 2 x 2.5" or 3 x 2.5"	
Expansion Slots	4	
Motherboards	6.7" x 6.7" (Mini ITX), 9.6" x 9.6" (Micro ATX)	
I/O Port	USB 3.0 x 2, USB 2.0 x 1, HD Audio x 1	
PSU	Standard PS2 PSU <b>(optional)</b>	
Fan Support	<b>Front:</b> 3 x 120mm, 2 x 120mm, 1 x 120mm 2 x 140mm, 1 x 140mm <b>Top:</b> 2 x 120mm, 1 x 120mm 2 x 140mm, 1 x 140mm <b>Rear:</b> 1 x 120mm	
Radiator Support	<b>Front:</b> 1 x 240mm, 1 x 120mm 1 x 280mm, 1 x 140mm <b>Top:</b> 1 x 240mm, 1 x 120mm 1 x 140mm <b>Rear:</b> 1 x 120mm	
Clearance	<b>CPU cooler height limitation:</b> 160mm <b>VGA length limitation:</b> 300mm(With radiator) 350mm(Without radiator) <b>PSU length limitation:</b> 200mm (With HDD Cage)	

## Packaging

Package Information	Divider 170 TG ARGB	Divider 170 TG ARGB Snow
EAN Code	4713227531191	4713227531207
UPC Code	841163081204	841163081211
N.W	5.26 kg / 11.6 lbs.	
G.W	6.16 kg / 13.6 lbs.	
Carton Size (L x W x H)	492 x 262 x 468 mm / 19.4 x 10.3 x 18.4 inch	
Cuft	2.13	
Container	w/o pallet	
20'	540 pcs	
40'	1080 pcs	
40' HQ	1200 pcs	



## Appearance – Black version



Angle view



Left Side view



Front view



Right Side view



Internal Structure



Rear view

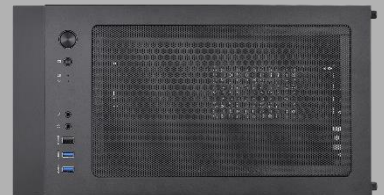

Top view



Bottom view



# Thermaltake Divider 170 TG ARGB Micro Case

Appearance –  
Snow version



Angle view

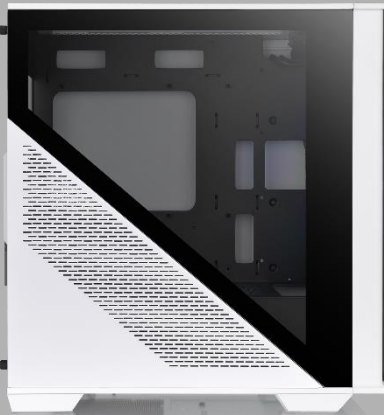

Left Side view



Front view



Right Side view



Internal Structure



Rear view

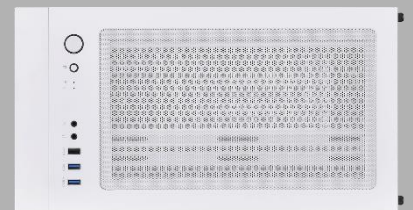

Top view



Bottom view



## Clearance



Maximum supports up to 120mm fan x 6

Maximum radiator supports up to 280mm at front

## Unique Design



## Unique Side Panel Design

## Structure (External)



**USB 3.0 x 2**

**USB 2.0 x 1**

**HD Audio**

## Structure (Internal)



Top filter

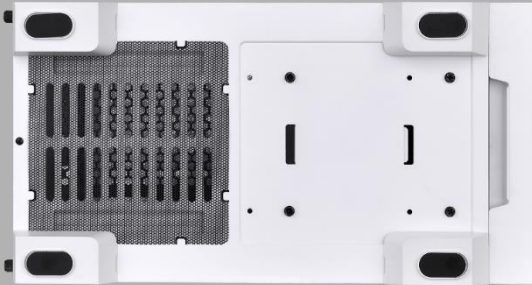

Bottom filter

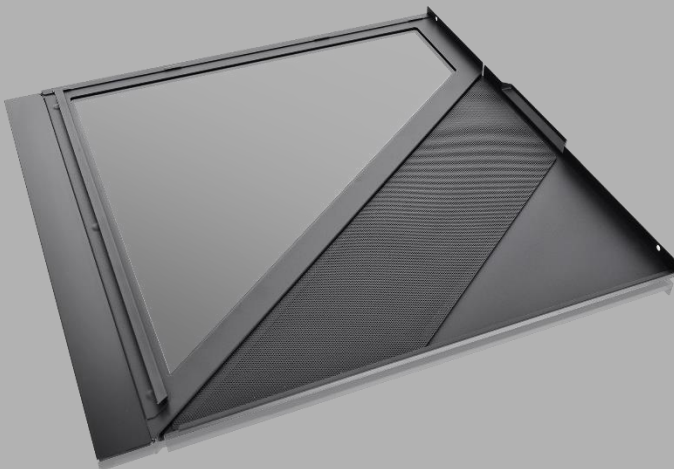

Left side filter



## Pre-installed ARGB PWM Fans



Pre-installed two hydraulic bearing 120mm ARGB PWM fans which can effectively lower the operation noise and enhance the thermal efficiency.



Divider 170 TG ARGB



Divider 170 TG ARGB Snow

### SPEC for Case ARGB PWM fans

- Fan Speed: 500~1500 RPM
- Max. Fan Airflow: 56.1 CFM
- Max. Fan Air Pressure: 1.11 mm-H2O
- Fan Noise Level: 27.2 dBA
- Fan Bearing: Hydraulic bearing

## ARGB lighting Control Instruction

### I/O Port



- Wave Mode** Mode 1
- Flow Mode** Mode 2
- RGB Lighting** Mode 3 (Single Color)
- Radar Mode** Mode 4~10  
(Red, Yellow, Green, Cyan, Blue, White, Purple)
- Breath Mode** Mode 11~18  
(RGB, Red, Yellow, Green, Cyan, Blue, White, Purple)
- Full Lighted Mode** Mode 19
- Single Color** Mode 20~26  
(Red, Yellow, Green, Cyan, Blue, White, Purple)
- Light Off** Mode 27

※ Long press on RGB button for 3 seconds, fan will blink twice which now are controlled by MB software. And vice versa.

### How to connect MB

#### ASUS/ASRock/BIOSTAR

Aura Addressable Strip Header(s)

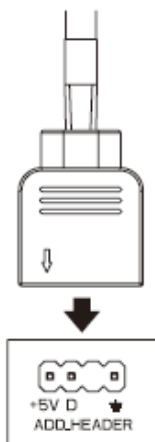

#### MSI

JRGB-strip Header(S)



#### GIGABYTE

AOURS RGB Fusion with Digital LEDs



## Compatibility List

Fan Compatibility List			
	120mm	140mm	200mm
Front	3	2	-
Top	2	2	-
Rear	1	-	-

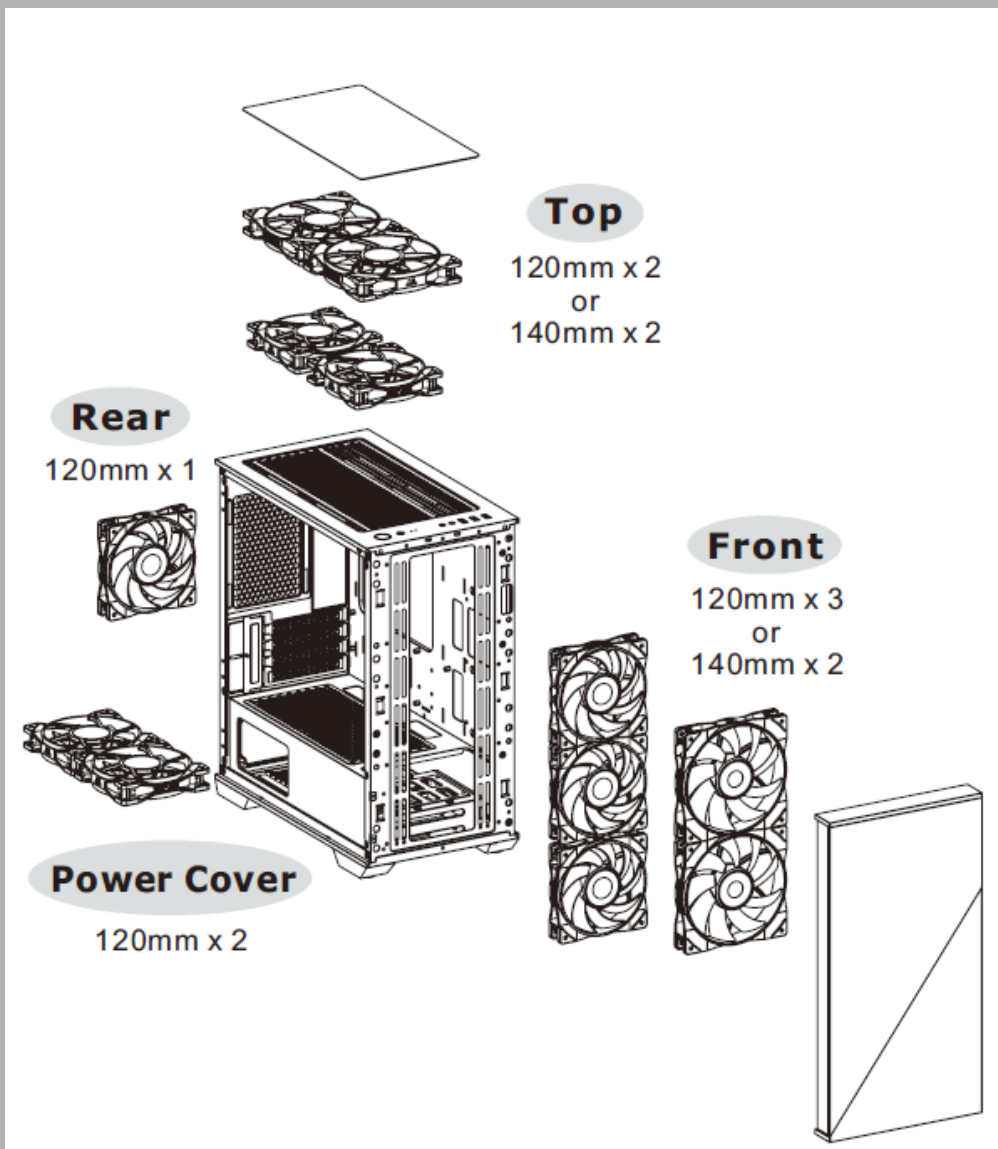

## All-in-One Compatibility

All-in-One Compatibility List						
	120mm	240mm	360mm	140mm	280mm	420mm
Front	●	●	-	●	●	-
Top	●	●	-	●	-	-
Rear	●	-	-	-	-	-

