

CREALITY

CREATE REALITY, ACHIEVE DREAMS

HALOT-SKY



HALOT-SKY

3D Printer User Manual

V1.1

Dear Consumers

Thank you for choosing our products. For the best experience, please read the instructions before operating the Printer. Our teams will

always be ready to render you the best services. Please contact us via the phone number or e-mail address provided at the end when you encounter any problem with the Printer.

For a better experience in using our product, you can also learn how to use the printer in the following ways:

View the accompanied instructions and videos in the U disk.

Visit our official website www.creality.com to find relevant software/hardware information, contact details and operation and maintenance instructions.

Firmware Upgrade

Please login the official website <https://www.creality.com/download>, switch the language and select the relevant printer and model and download the required firmware, you can use it after the installation is finished.

- 1 Do not use the printer any way other than described herein in order to avoid personal injury or property damage.
- 2 Do not place the printer near any heat source or flammable or explosive objects. We suggest placing it in a well-ventilated, low-dust environment.
- 3 Do not expose the printer to violent vibration or any unstable environment, as this may cause poor print quality.
- 4 Please use recommended resin to in case damage of machine.
- 5 Do not use any other power cable except the one supplied. Always use a grounded three-prong power outlet.
- 6 Please do not open the plastic cover during usage, otherwise the printing will be interrupted.
- 7 Do not wear cotton gloves when operating the printer. Such cloths may become tangled in the printers moving parts leading to burns, possible bodily injury, or printer damage.
- 8 Please wait a moment after the print is finished. And please wear gloves to take out the print by tools.
- 9 Clean the printer frequently. Always turn the power off when cleaning, and wipe with a dry cloth to remove dust, adhered printing plastics or any other material off the frame, guide rails, or wheels. Use glass cleaner or isopropyl alcohol to clean the print surface.
- 10 Children under 10 years should not use the printer without supervision.
- 11 This machine is equipped with a security protection mechanism. Do not manually move the nozzle or printing platform mechanism manually while booting up, otherwise the device will automatically power off for safety.
- 12 Users should comply with the laws and regulations of the corresponding countries and regions where the equipment is located (used), abide by professional ethics, pay attention to safety obligations, and strictly prohibit the use of our products or equipment for any illegal purposes. Creality will not be responsible for any violators' legal liability under any circumstance.

Introduction	01-01
Parameters	02-02
Parts List	03-03
Assemble the 3D Printer	04-04
Use the 3D Printer	05-11
Start Printing	12-14
Control remote printing	15-15
Wiring Connection	16-16
Troubleshooting	17-17
LCD 3D PRINTING FILAMENTS	18-20
Warranty Card	21-22

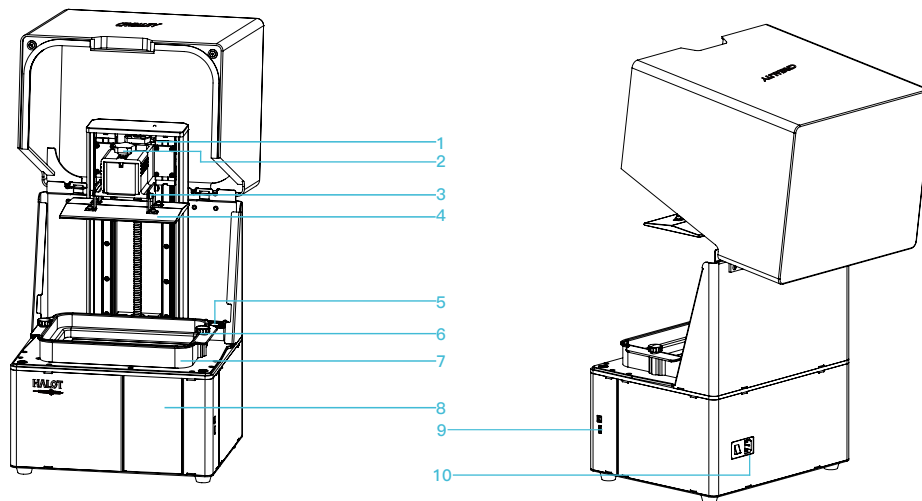

1 Limit switch

2 Hexalobular socket screw

3 Leveling screw

4 Building platform

5 Air filter

6 Hexalobular socket screw

7 Resin vat

8 Touch screen

9 USB port

10 Power socket

Basic Parameters

Model Name	HALOT-SKY
Build Size	192*120*200mm (length,width and height)
XY Axis Resolution	3840*2400
XY Axis Accuracy	0.05mm
Print speed	1-4s/layer
Layer Thickness	0.01-0.2mm
Touch Screen	5 inch touch screen
Light Source Type	Integral light source (wavelength 405nm)
Rated Voltage	100-240Va.c, 50/60Hz
Rated Power	250W
Machine Size	340*292*552mm
Package size	450*390*705mm
Net Weight	16.5KG
Gross Weight	22.45KG
Print Method	USB Disk, Creality Cloud
Machine Language	中文(简/繁)/ English/ Español/ Deutsche/ Français/ Русский/ Português/ Italiano/ Türk/Nederlands/Polskie/日本語/한국어
Slicing Software Operation System	Win7/Win8/Win 10 64bit, Mac system (32-bit is not supported)
Compatible Resin	Common rigid photosensivie resin, Standard resin, Hight hardness,Compatible Resin High toughness, Dental model resin.

3. Package Content

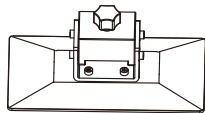

1 Print platform x 1

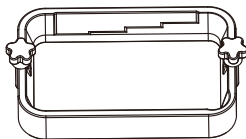

2 Resin vat x 1

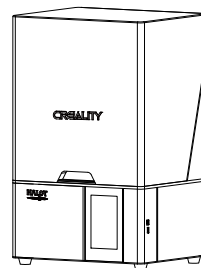

3 3D printer x 1

Tool list



1 U disk x 1



2 Screwdrivers x 1set



3 Brush x 1



4 Plastic blade x 1



5 Resin filter x 4



6 Release film x 1



7 Metal blade x 1



8 Power cord x 1



9 Vat cover x 1



10 Calibration card x 1

Tips: the above accessories are for reference only, in kind prevail!

4. Assemble the 3D Printer

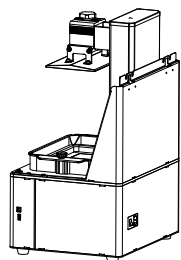

1 Machine body x 1

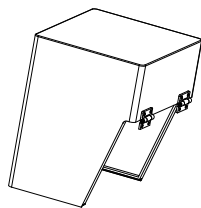

2 Plastic cover x 1

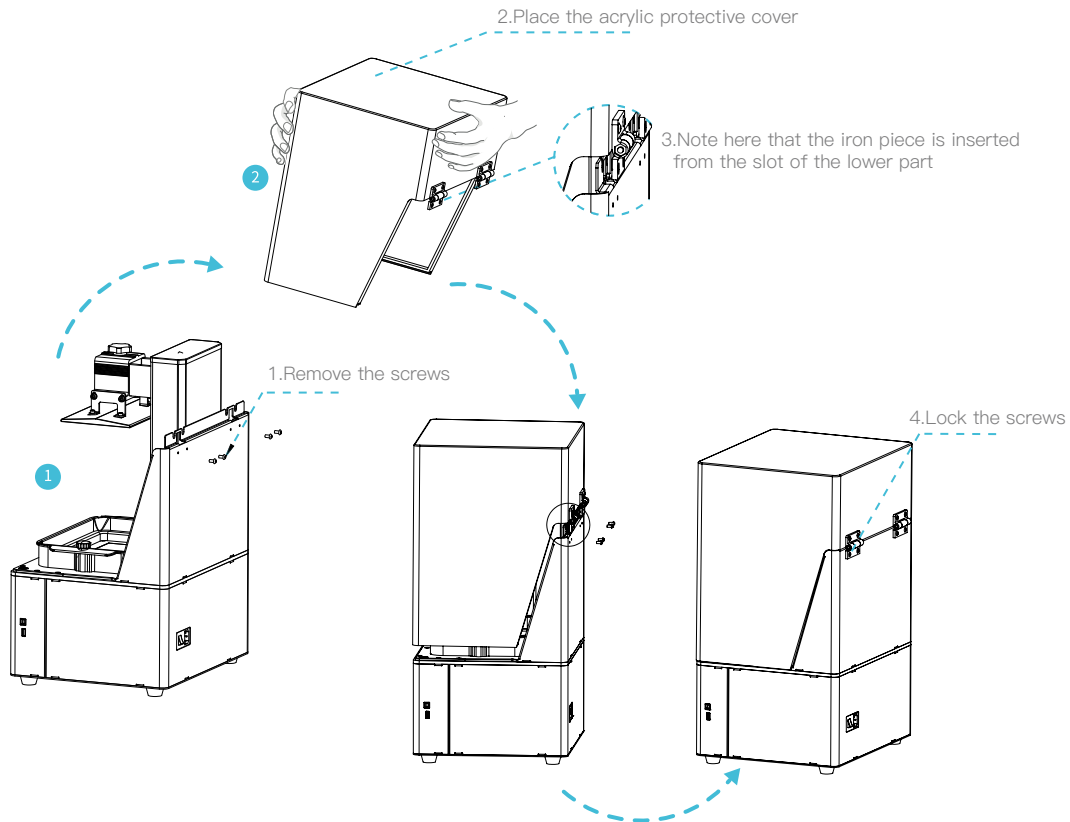

Setting

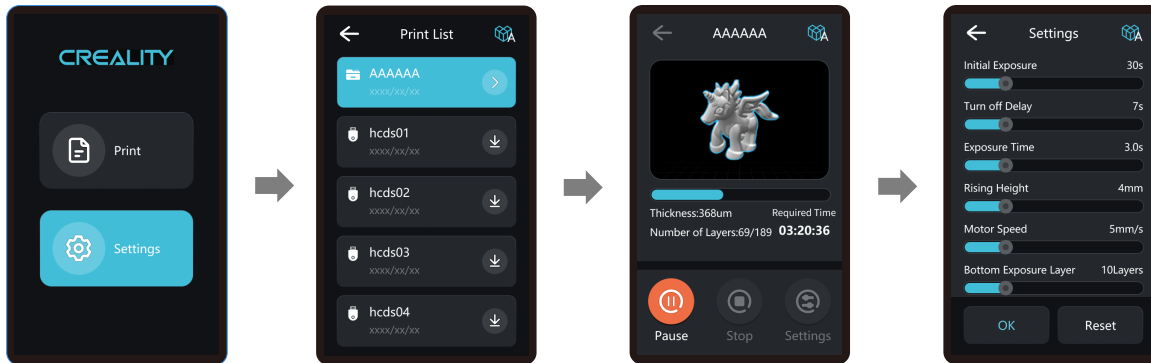

Note: The current interface is for reference only, due to the continuous upgrading of functions, the actual to the official website of the latest firmware UI as the standard.

Setting



Note: The current interface is for reference only, due to the continuous upgrading of functions, the actual to the official website of the latest firmware UI as the standard.

6. Level Platform

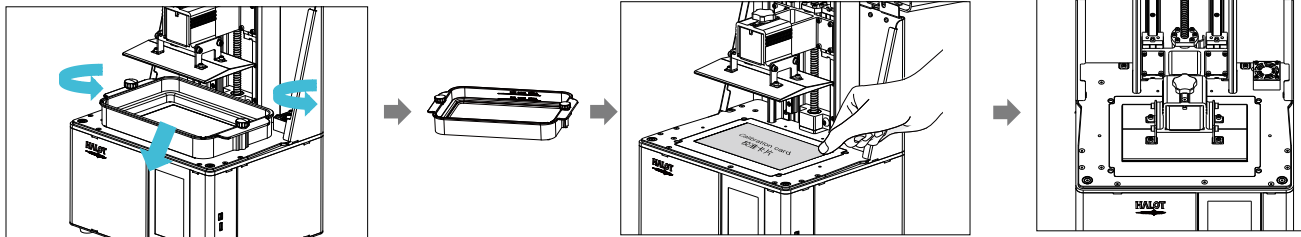

1. First raise the platform, then loosen rubber screws on the left and right sides of the resin vat, and take out the resin vat.

2. Place the calibration card on the printing screen, go “Tools → Manual → Home” with the touch screen, and check whether the platform sticks into the calibration card evenly.



Note: The printing platform has been leveled at the factory. If it needs leveling due to transportation or other reasons, please follow the steps below to adjust the printing platform.

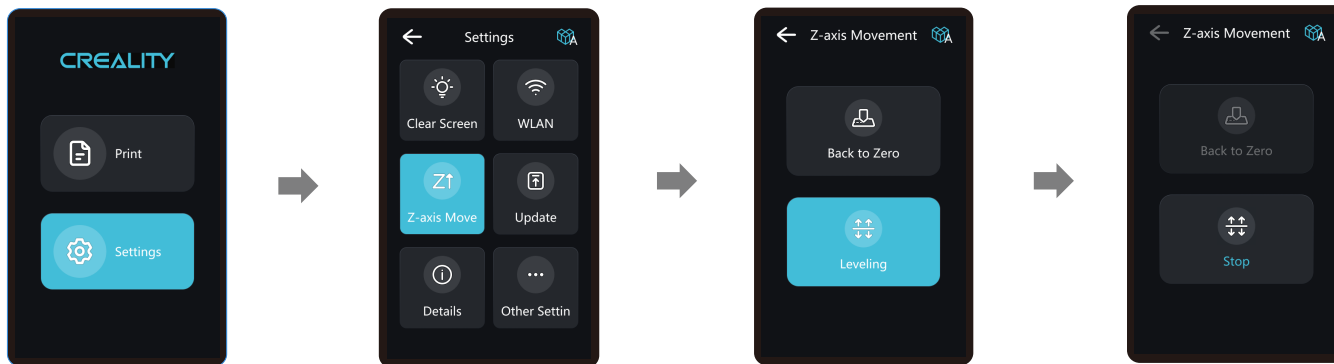

Note: The current interface is for reference only, due to the continuous upgrading of functions, the actual to the official website of the latest firmware UI as the standard.

7. Load Resin

Pour the UV photosensitive resin into the resin vat. The slot capacity is 500ml/1000ml.

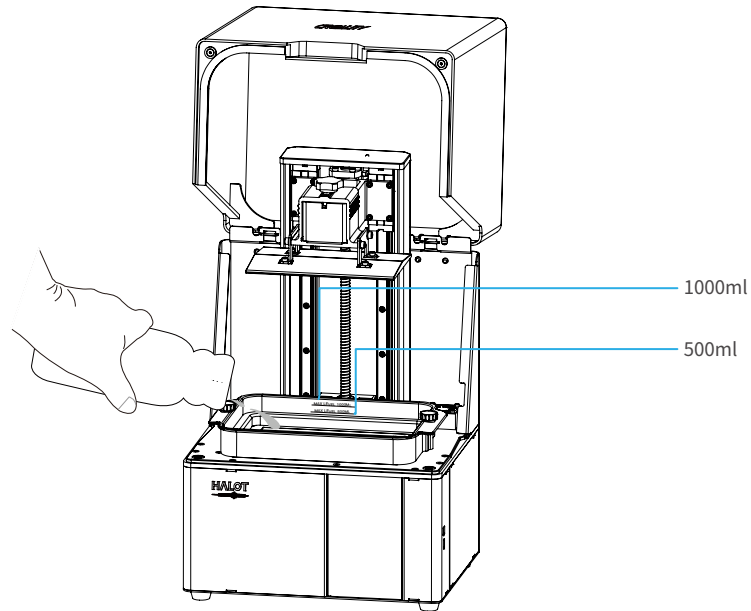

Tips: How to change resin:

Take out the resin vat slowly, pour out the remaining resin into the container, clean the resin vat, pour in new resin, and then install the resin vat to the machine.



Caution : Resin may cause skin irritation or an allergic skin reaction. Please wear gloves before use to avoid direct contact with the skin.

Installation steps

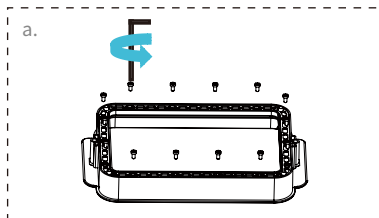

a. First, remove the 14 screws at the bottom of the vat and take down the old release film.

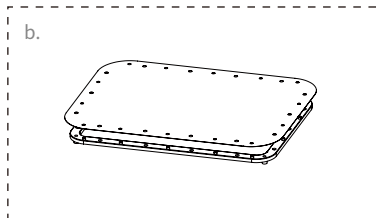

b. Prepare the new release film, peel off the the protective films on both sides of the release film. Align the holes and fit the release film on the clamping ring.

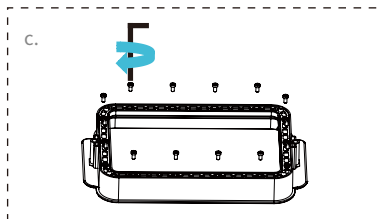

c. Finally, place the film-ring assembly back into the vat frame gently, then install and tighten the fixing screws diagonally.

d. The installed release film is as shown.

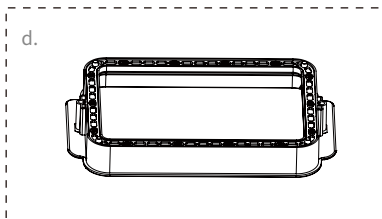

Parameters



Size 190mm*266mm



Thickness: 0.15-0.2mm



95%
(Light Transmittance)

1. Slicer

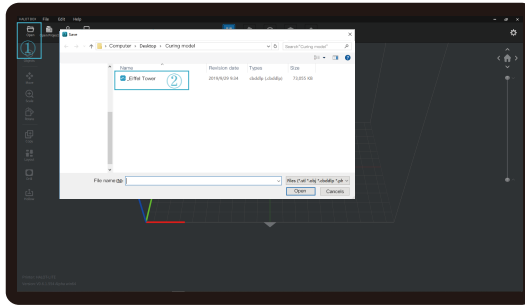

1. Open the slicer software of LCD 3D printer, click “open” on the left of the screen and add model file.

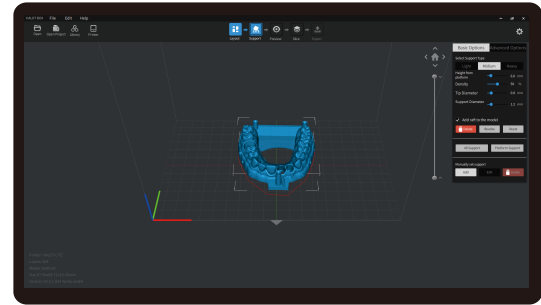

2. If the model needs to add support, click the upper left icon to set corresponding parameters.

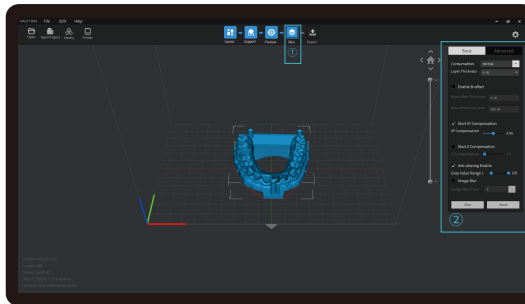

3. Click icon ①→Setting slice printing parameters②→Click

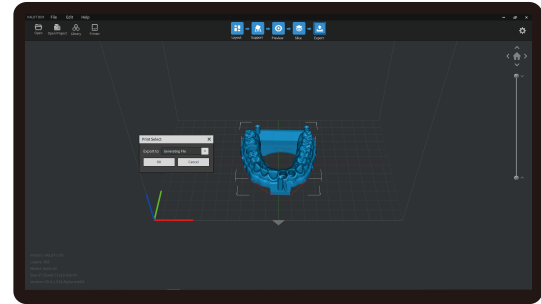

4 wait for slice to be finished→save the sliced file (Please refer to the official website www.creality.com for more details of slicing tutorial).



Note: The UI interface is for reference only, and shall be subject to the actual UI may be different.

2. Print

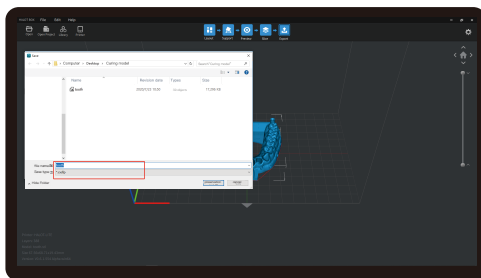

1. Generate cxldp file and save the file to U disk

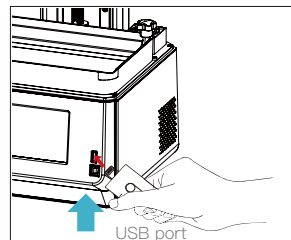

2. Insert the USB disk → Press the print button.



Warning: Please don't insert or remove U disk during printing.



Note: The UI interface is for reference only, and shall be subject to the actual UI.

9. Start Printing

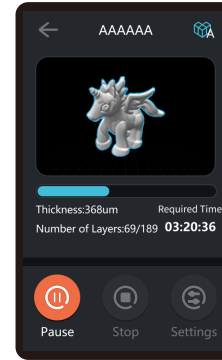
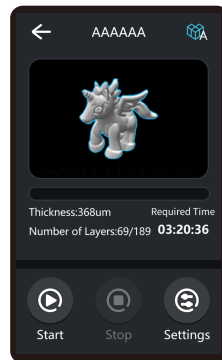
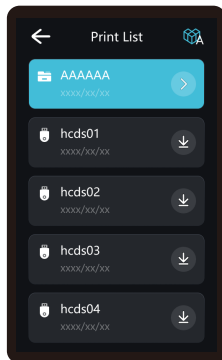
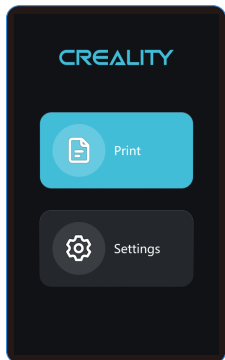

1. select files.

2. Select the file to be printed and press "Start".

3. Printing.

10. Control remote printing



1.Download



2.Register



3.Log in



4. Scan QR Code



5. Add equipment



6. Select device



7. check printing status



8.Print Progress

11. Wiring Connection

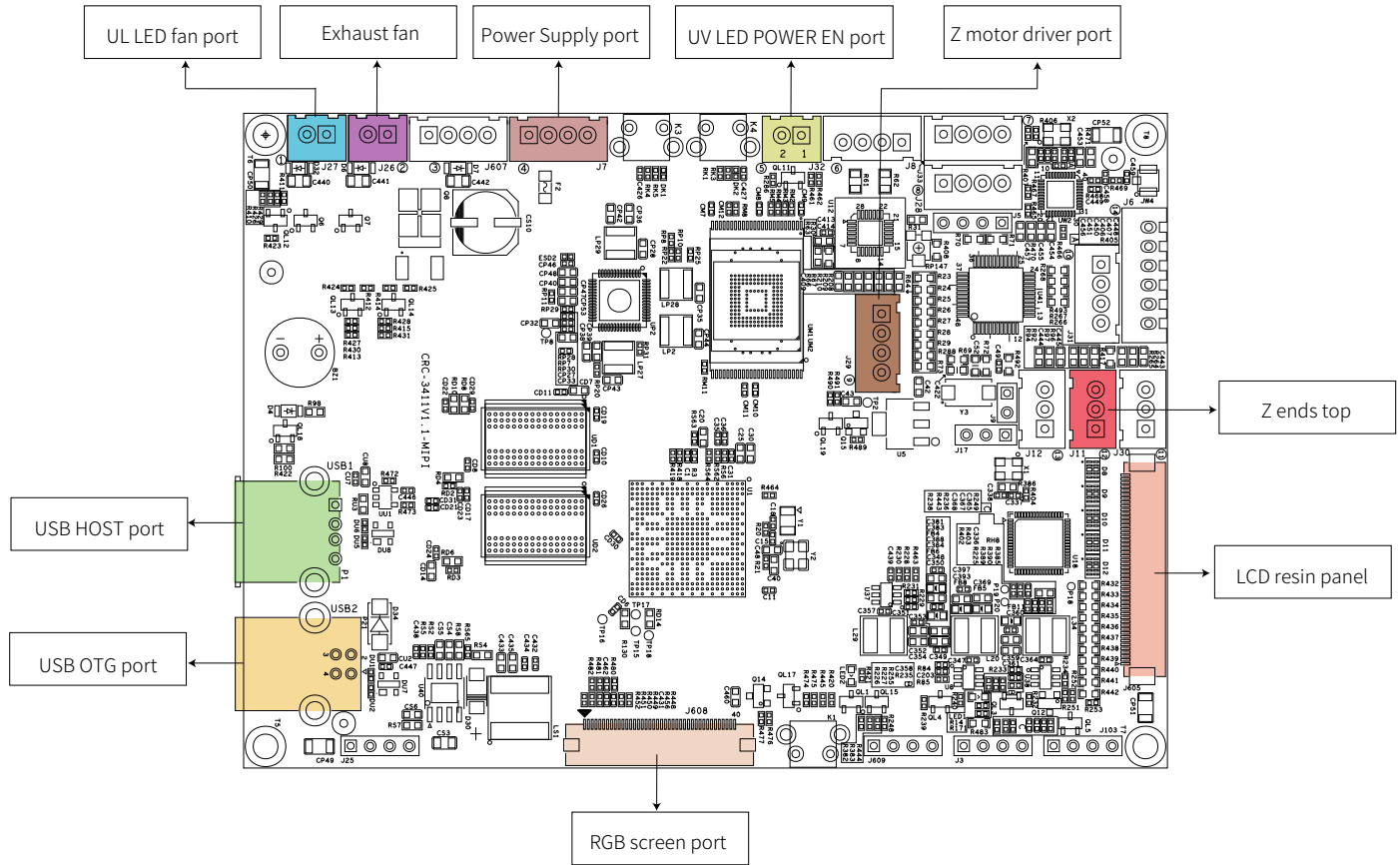

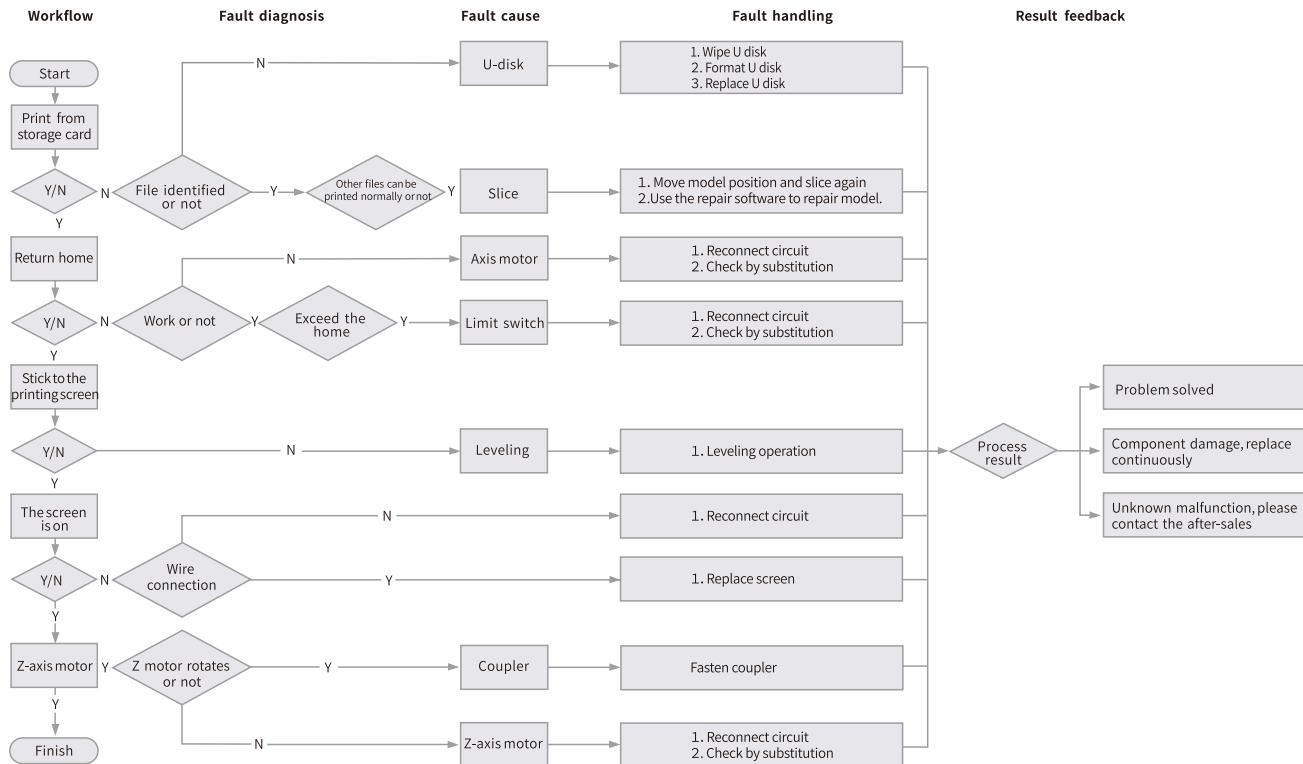

FDM 3D PRINTING FILAMENTS



HP-PLA

Upgraded environmentally friendly formula, matte effect, high toughness, and fine printing. The raw materials are imported from the United States, besides, there are rich colors for customers to choose.



CR-PLA CR-PETG
CR-ABS CR-TPU

Targeting at mid-end users, CR series is with transparent tray plus black-white color box design. Its slight tolerance in wire diameter contributes to stable printing quality. CR series meets your demands of daily design and prototype making.



HC-PLA HC-PETG
HC-ABS HC-TPU

HC series is cost-efficient. It's widely applicable to general FDM printer product designs on the market to meet your daily design and different prototyping needs.



EN-PLA EN-PETG
EN-ABS EN-TPU

Ender series is widely applied to general FDM printer design, which meet customers' needs of daily design and different prototyping needs.

3D PRINTER UV SENSITIVE RESIN

Standard Resin

Low shrinkage, fast printing speed, almost odorless, and it's equipped with rigidity and toughness, suitable for printing common product prototypes and display models, that's also highly compatible with LCD printers.

Low Odor Resin

Low odor, high precision, detail textures are very expressive. Good fluidity, high printing success rate. Rich colors, to meet the customer's color needs, preferred for animation manual, craft furnishing industry, etc..

ABS Like Resin

With high hardness, high toughness of physical properties and strong impact resistance, it can be directly drilled on the finished models, mainly used in industrial prototype and other fields.

Dental Cast Resin

Low shrinkage, due to the low shrinkage characteristics, the size is more accurate. It's not easy to deform under pressure after molding. Used for making porcelain teeth.

Elastic Resin

Elastic Resin features good elasticity after high-strength extruding or stretching, widely applied to damping and contacting surfaces, etc., preferred to be used by people full of originality and ideas in design.

Water Washable Resin

The model can be washed with water directly, and it's safe, environmentally friendly, with high surface accuracy, short cleaning time and low material cost. Water Washable Resin is currently one of the favorite new materials for schools, educational institutions and printing enthusiasts.

Dental Mode Resin

The surface hardness is extremely high, scratch-resistant, and has low shrinkage characteristics. It is mainly used in dental implant restoration and invisible braces printing in medical dentistry.

Toughness Resin

Toughness Resin is a medium-hard, wear-resistant, and repeatedly stretchable material. It is used in parts which need to be repeatedly stretched in friction devices.

High Temperature Resin

High Temperature Resin is mainly used in making high temperature rubber molds, which can withstand temperatures of about 200°C without cracking and maintain good strength, stiffness and thermal stability.

Jewelry Cast Resin

Widely applied to jewelry industry. Excellent combustion performance, low expansion coefficient, combustion without residue. Forming process is stable without deformation. The finished product has smooth surface and high precision.

20. UV sensitive resin parameter information

Related Parameters	Standard Resin	ABS Like Resin	Dental Cast Resin	Elastic Resin	Water Washable Resin	Dental Mode Resin	Toughness Resin	High Temperature Resin	Jewelry Cast Resin
Viscosity	150-250MPa·s (NDJ-85 Rotational Viscometer (25°C))	200-350MPa·s (NDJ-85 Rotational Viscometer (25°C))	50-170MPa·s (NDJ-85 Rotational Viscometer (25°C))	300-1000MPa·s (NDJ-85 Rotational Viscometer (25°C))	100-350MPa·s (NDJ-85 Rotational Viscometer (25°C))	150-300MPa·s (NDJ-85 Rotational Viscometer (25°C))	150-300MPa·s (NDJ-85 Rotational Viscometer (25°C))	150-300MPa·s (NDJ-85 Rotational Viscometer (25°C))	100-150MPa·s (NDJ-85 Rotational Viscometer (25°C))
Absorption Band	355nm-410nm	355nm-410nm	355nm-410nm	385nm-410nm	385nm-410nm	355nm-410nm	355nm-410nm	355nm-410nm	355nm-410nm
Liquid Density	1.05-1.25g/cm ³ (Density meter (25°C))	1.05-1.13g/cm ³ (Density meter (25°C))	1.05-1.25g/cm ³ (Density meter (25°C))	1.05-1.25g/cm ³ (Density meter (25°C))	1.05-1.25g/cm ³ (Density meter (25°C))	1.05-1.25g/cm ³ (Density meter (25°C))	1.05-1.25g/cm ³ (Density meter (25°C))	1.05-1.25g/cm ³ (Density meter (25°C))	1.05-1.13g/cm ³ (Density meter (25°C))
Flexural Modulus	1.882-2.385Mpa	1.192-2.525Mpa	1.192-2.525Mpa	1.882-2.385Mpa	1.882-2.385Mpa	1.882-2.385Mpa	1.882-2.385Mpa	1.882-2.385Mpa	1.192-2.525Mpa
Bending Strength	59-70MPa	68-80MPa	49-58MPa	40-70MPa	40-70MPa	59-70MPa	40-70MPa	59-70MPa	49-58MPa
Heat Distortion Temperature	80°C	80°C	75°C	80°C	80°C	80°C	80°C	220°C	65°C
Thermal Expansion Coefficient	95*E-6	95*E-6	95*E-6	95*E-6	95*E-6	95*E-6	95*E-6	95*E-6	95*E-6
Volume Shrinkage	3.72-4.24%	3.72-4.24%	1.88-2.45%	3.72-4.24%	3.72-4.24%	1.56-1.95%	3.72-4.24%	3.72-4.24%	4.06-5.08%
Linear Shrinkage	1.05-1.35%	1.05-1.35%	0.8-1%	1.05-1.35%	1.05-1.35%	0.85-1.05%	1.05-1.35%	1.05-1.35%	1.05-1.35%
Tensile Strength	36-52MPa	42-62MPa	42-62Mpa	30-52MPa	30-52MPa	42-62MPa	30-52MPa	36-52MPa	42-62MPa
Tensile Modulus	1.779-2.385MPa	1.86-2.645MPa	1.86-2.645MPa	1.779-2.385MPa	1.779-2.385MPa	1.779-2.385MPa	1.779-2.385MPa	1.779-2.385MPa	1.86-2.645MPa
Elongation at Break	11%-20%	11%-21%	11%-20%	200%	120%	11%-20%	130%	11%-20%	11%-20%
Shore Hardness	84D	75-80D	80-88D	20-30D	80-85D	82D	65-75D	86D	65D
Glass Transition Temperature	100°C	100°C	78°C	100°C	100°C	100°C	100°C	100°C	78°C
Solid Density	1.05-1.25g/cm ³	1.05-1.13g/cm ³	1.05-1.13g/cm ³	1.05-1.25g/cm ³	1.05-1.25g/cm ³	1.05-1.25g/cm ³	1.05-1.25g/cm ³	1.05-1.25g/cm ³	1.05-1.13g/cm ³
Notched Impact Strength	44-49J/m ²	60-80J/m ²	44-49J/m ²	41-48J/m ²	41-48J/m ²	41-49J/m ²	41-48J/m ²	44-49J/m ²	44-49J/m ²

21. Filaments Parameter Information

Material		Print Temp (°C)	Bed Temp (°C)	Difficulty	Flexibility	Shrinkage	Ductility	Applicable Models
PLA Series	HP-PLA	190-220	50-60	●	●●	●	●●●	Suitable for 99% FDM models
	HP-PLAx3	190-220	50-60	●	●●	●	●●●	Suitable for 99% FDM models
	CR-PLA	190-220	50-60	●	●●	●	●●●	Suitable for 99% FDM models
	HC/EN-PLA	190-220	50-60	●	●●	●	●●	Suitable for 99% FDM models
ABS		220-260	90-110	●●●●●	●●	●●●	●●●	Hot bed is needed, and Creality printer enclosure is recommended for DIY machine
PETG		230-250	60-100	●●●	●●	●●	●●●	Hot bed is needed, and Creality printer enclosure is recommended for DIY machine
TPU		210-240	50	●●	●●●●●●	●	●●●●	Direct extrusion models
Silk		190-220	50-60	●	●●	●	●●	Suitable for 99% FDM models
Nylon		230-260	80-90	●●●●●	●●●	●●●●	●●●●	Hot bed is needed, and Creality printer enclosure is recommended for DIY machine
Carbon (Ordinary type)		190-220	50-60	●	●	●	●●	Suitable for 99% FDM models
PDS Advertising word filament-PLA		190-220	50-60	●	●●	●	●●	Creality K5, K8, T5
Low temperature filament-PCL		60-100	-	●	●●●	●	●●●●	Low temperature 3D printing pen



SHENZHEN CREALITY 3D TECHNOLOGY CO., LTD.

Add : 18F, JinXiuHongDu Building, Meilong Blvd., Longhua Dist., Shenzhen, China 518131

Official Website: www.creality.com

Tel: +86 755-8523 4565

E-mail: info@creality.com cs@creality.com

www.creality.com

vip.creality.com



Scan the code to know more

Warranty Policy ←

- 1-year Limited Warranty since the date of product purchase.
- 6-months Limited Part Warranty for UV light.
- 3-months Limited Part Warranty for 2K Screen.
- No Warranty for the Release Film and Product Gift (U disk, Gloves, Screwdriver, Paper funnel, Brush, etc.)

What Is Covered? ←

Any defects in material, workmanship of product will be covered until you provide any relating documents and information, including but not limited to:

- User of the product are in the country of purchase
- Defective product is a CREALITY product
- Proof of Purchase

What Is Not Covered? ←

CREALITY does not guarantee the service as a result of:

1. The proof of purchase being altered or made illegible.
2. The product label or serial number on the product being altered or made illegible.
3. Normal wear of accessories or consumables for use as release film.
4. Malfunction or damage caused by personal retrofitting, or improper installation and usage.
5. Malfunction or damage caused by use in non-recommended working environments.
6. Malfunction or damage caused by overuse (overload) or wrong maintenance (damp, mildew, etc.)
7. Malfunction or damage caused by Force Majeure (fire hazard, earthquake, lightning and floods, etc.)
8. Malfunction or damage caused by the use of other brand parts or consumable.

Technical Support ←

Please enjoy our technical support of the whole lifetime (Except technical problem beyond product itself) after purchase the product while product documents as user manual attached in U disk for instruction.

Please provide product Serial Number when apply for technical support.

Kindly Notification ←

Please read the user manual and warranty card carefully before the use. For any service, Please priory contact local seller or contact us via [Email: cs@creality.com](mailto:cs@creality.com) for support.

See www.creality.com/after-service-policy/ for specific warranty information about your product and procedures to act on a warranty claim.

WARRANTY



Before returning the product and filling in a warranty, please contact after-sale person for going through after-sale formality. And attach this warranty card along with the returned machine.

Repair

Change

Return

Name: _____ Telephone: _____

Address: _____

Serial Number: _____ Order Number: _____

Channel: Platform Offline

Date of purchase Day _____ Mon. _____ Year _____

Malfunction And Damage Depiction Or Return And Change Reasons\ Suggestions:

Repair Records:

↓
Note: Client need filling in basic infor. and return reasons. Repair records shall retain for technicians.



Due to the differences between different machine models, the physical objects and the final images can differ. The final explanation rights shall be reserved by Shenzhen Creality 3D Technology Co., Ltd.



SHENZHEN CREALITY 3D TECHNOLOGY CO., LTD.

Add: 18F, JinXiuHongDu Building, Meilong Blvd., Longhua Dist.,

Shenzhen, China 518131

Official Website: www.creality.com

Tel: +86 755-8523 4565

E-mail: info@creality.com cs@creality.com

